

(1, 1)

Beplankung 3mm nachträglich, wenn Rumpffrahmen

Nase

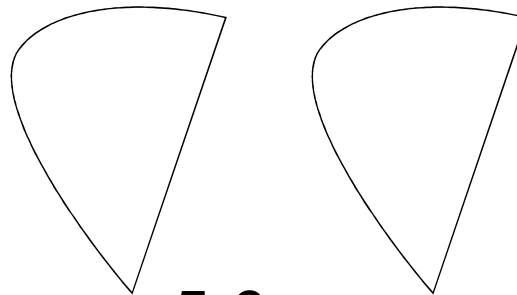

5-6mm

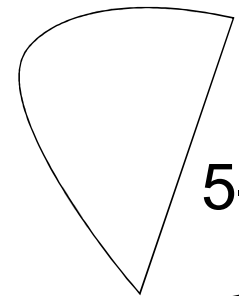
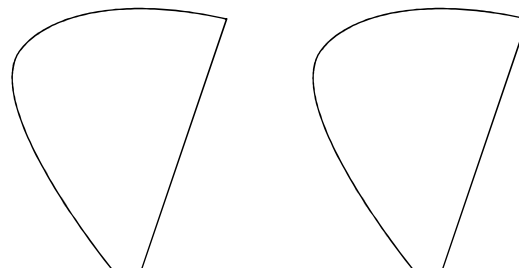

5-6mm

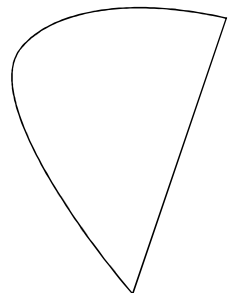

zusammengenaut, aufbringen und auf Maß schneiden!

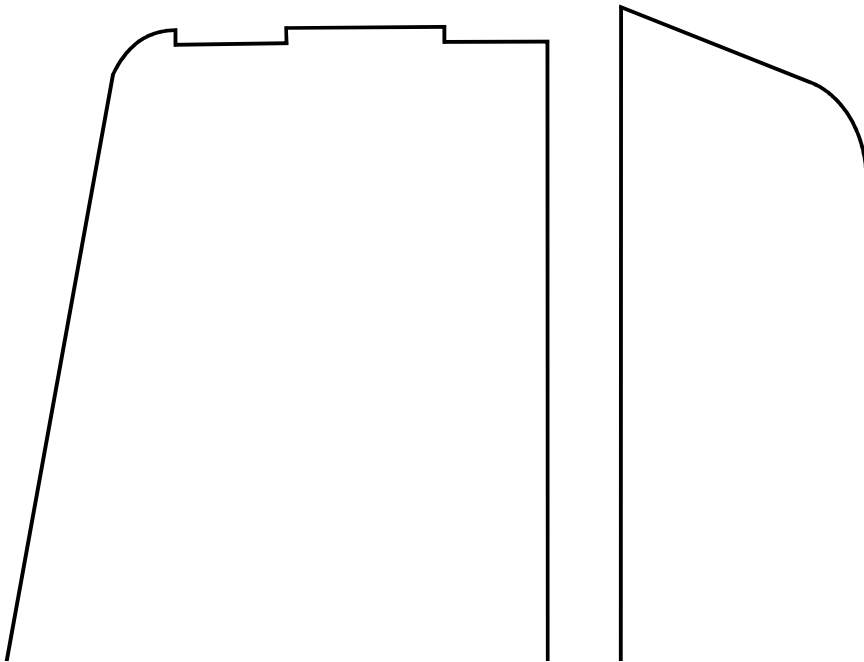

(1, 2)

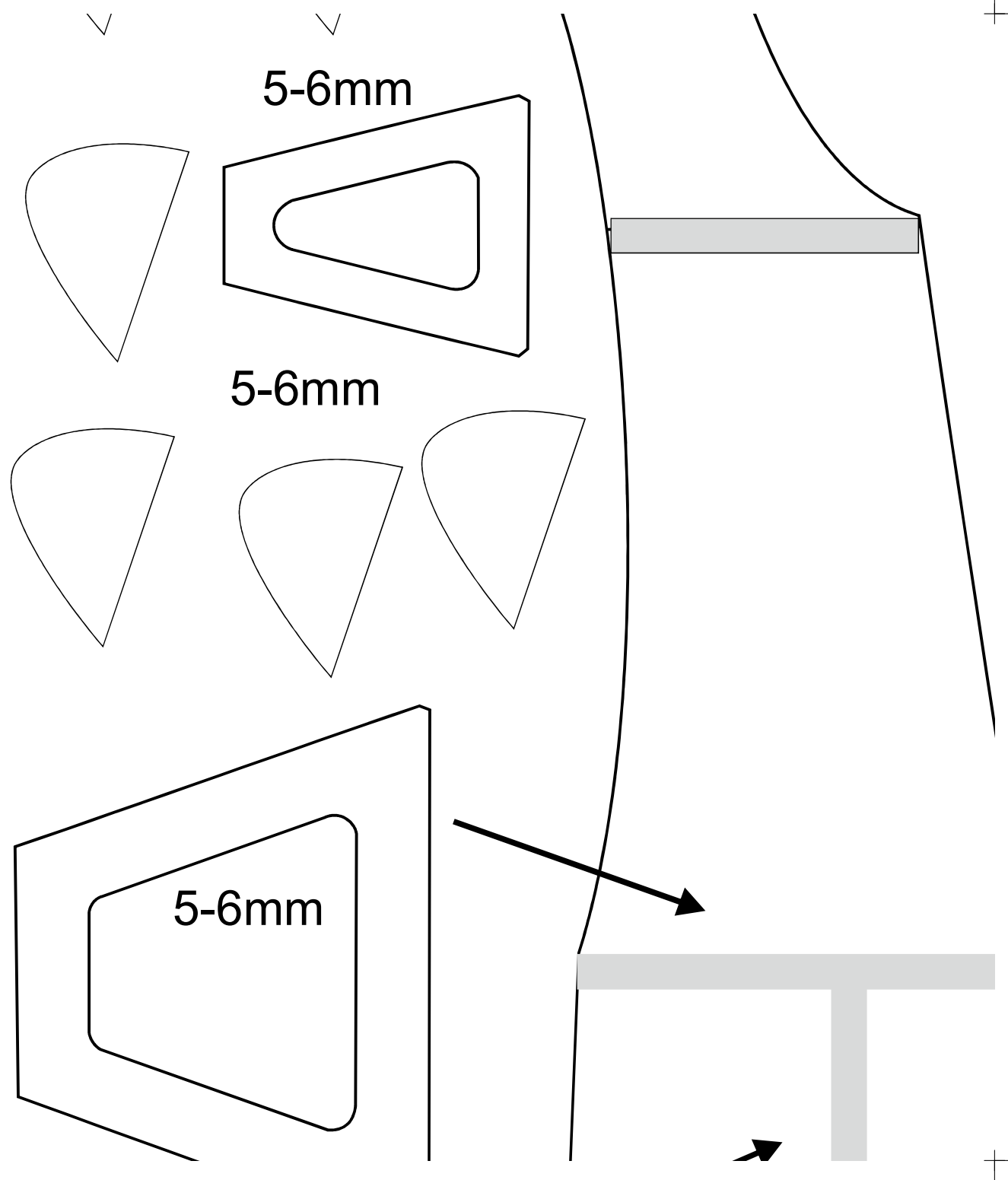

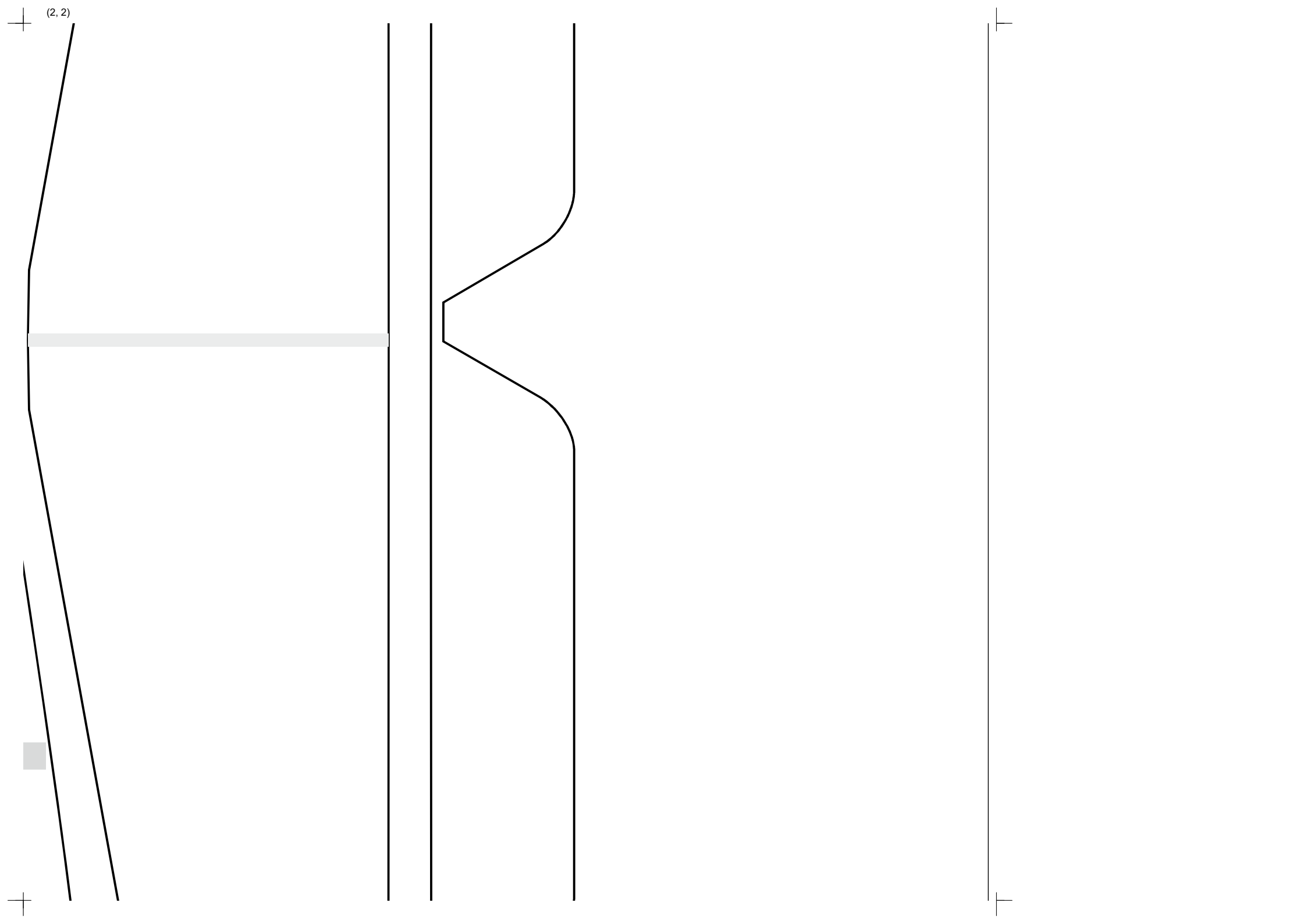

(1, 3)

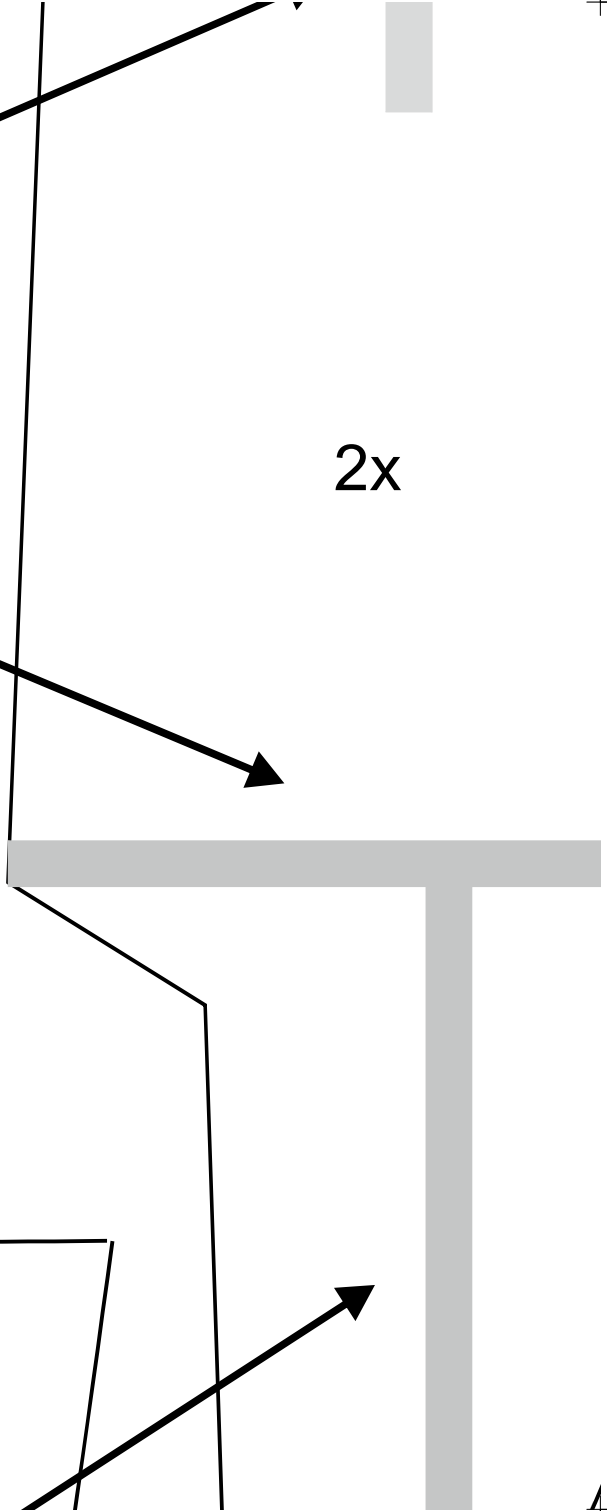
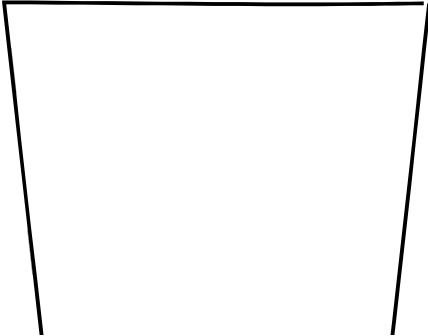
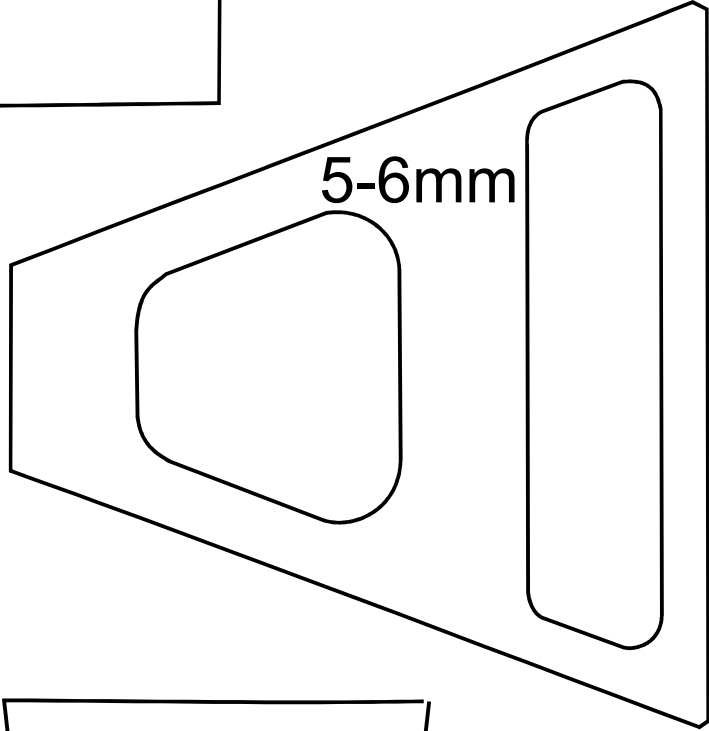
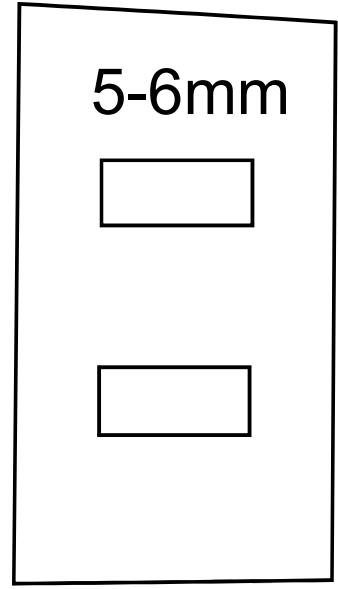

(2, 3)

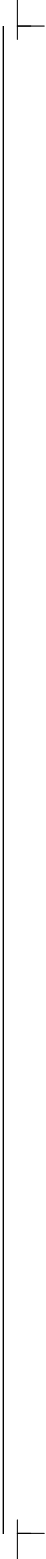
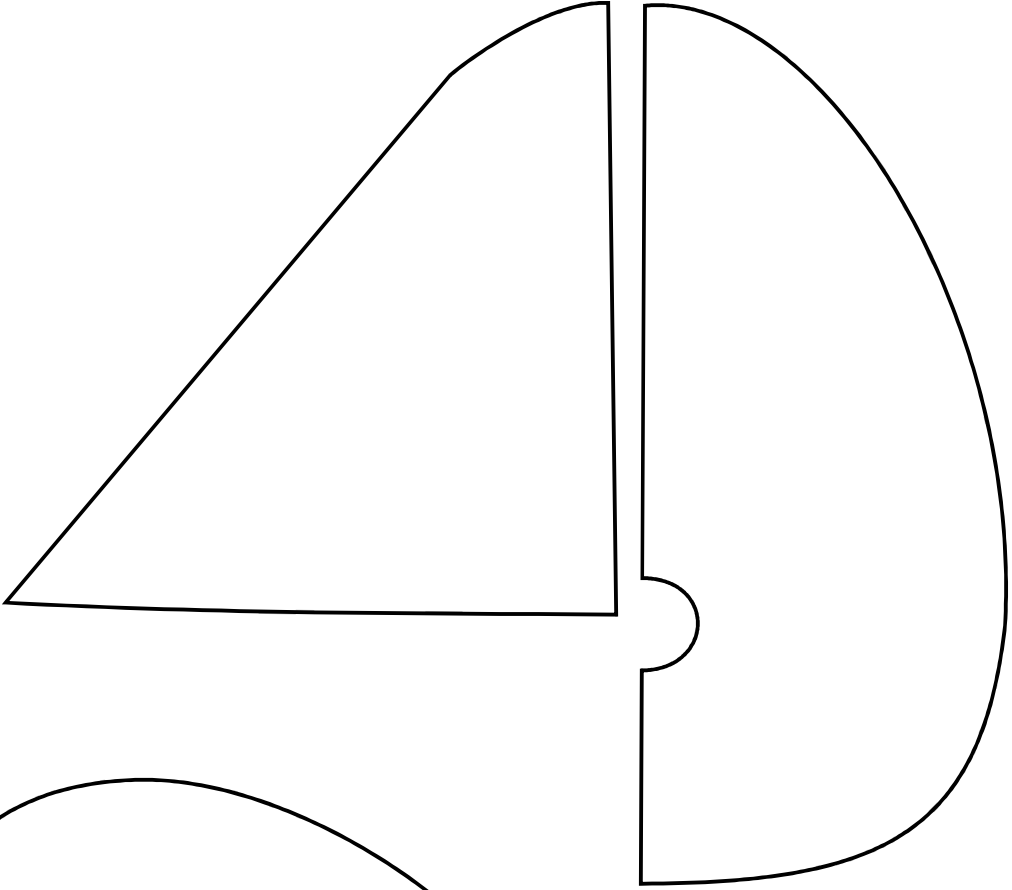
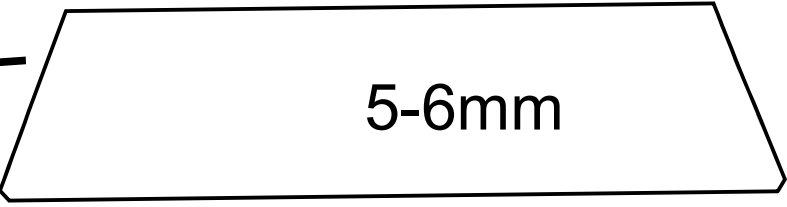
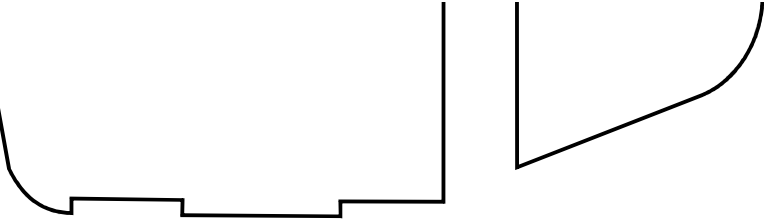
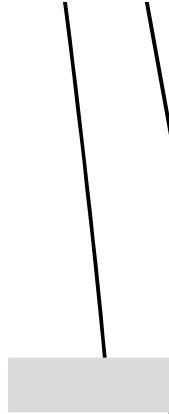

(1, 4)

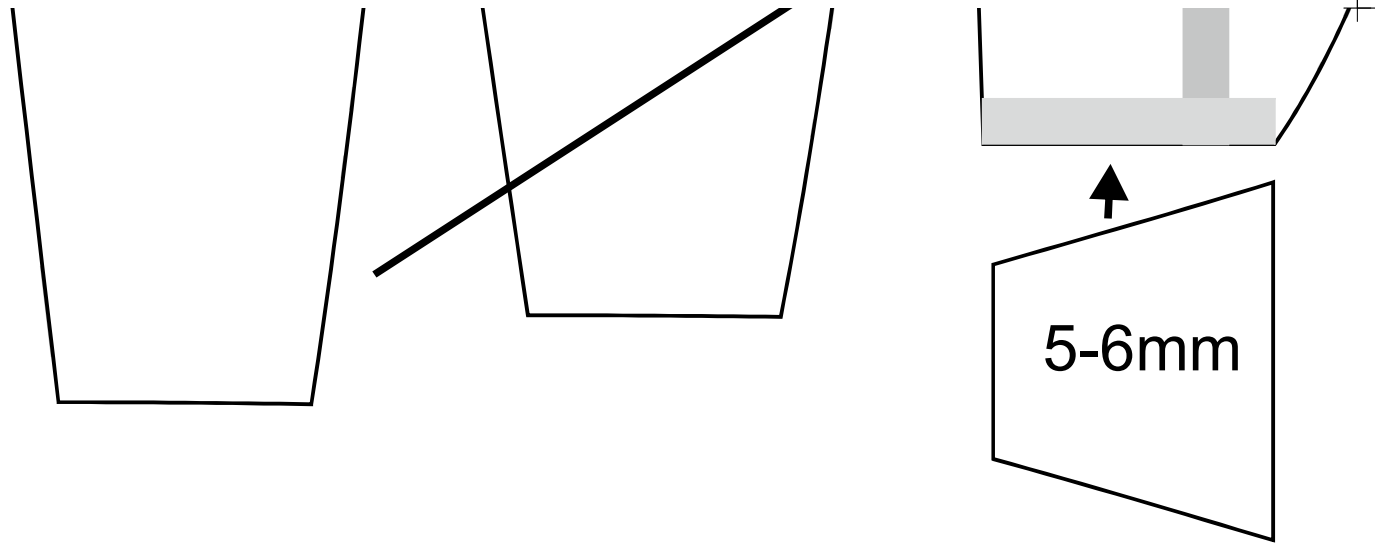

Sofern nicht anders angegeben alle Teile 3

(2, 4)

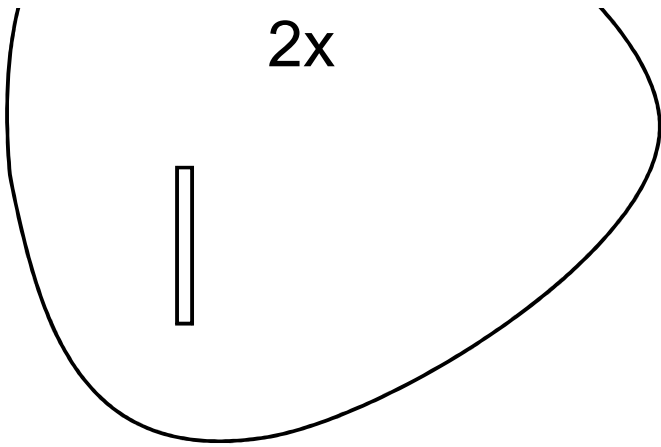

2x

3mm Depron

(1, 1)

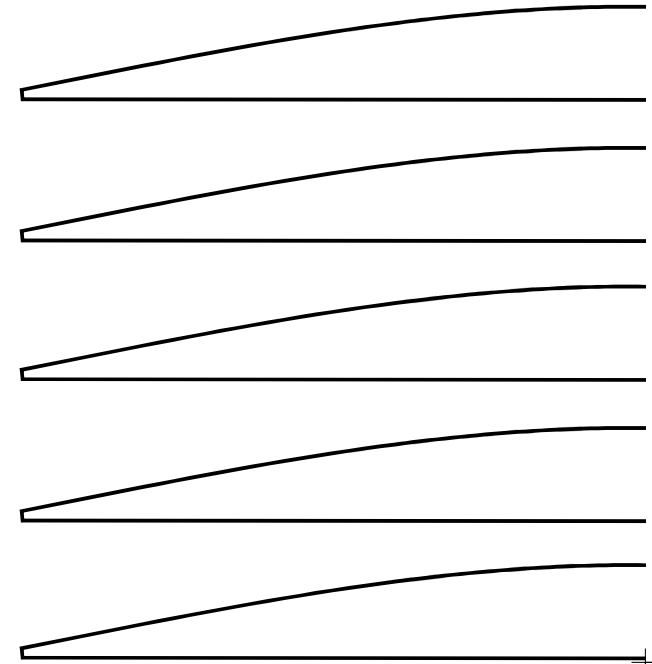
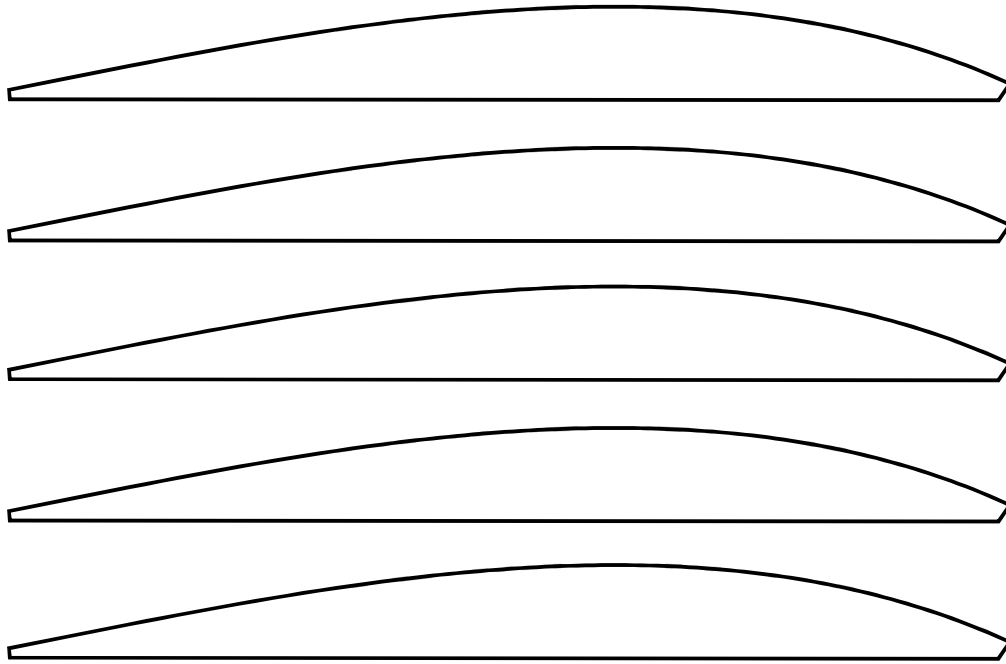

(2, 1)

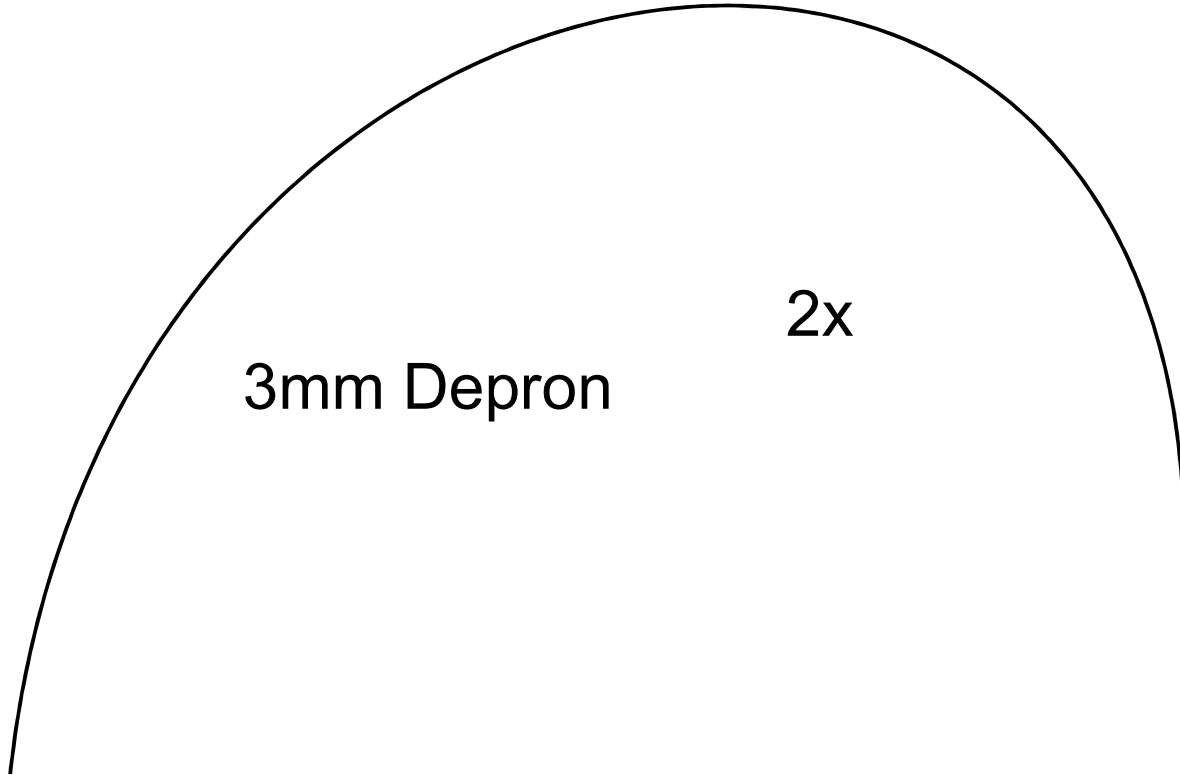
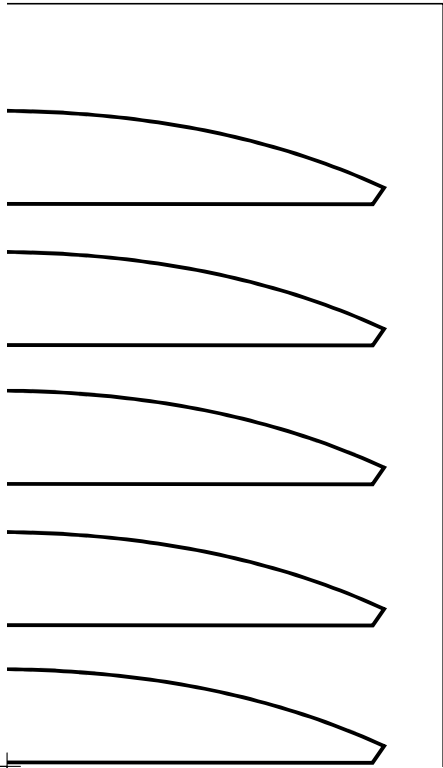

3mm Depron

2x

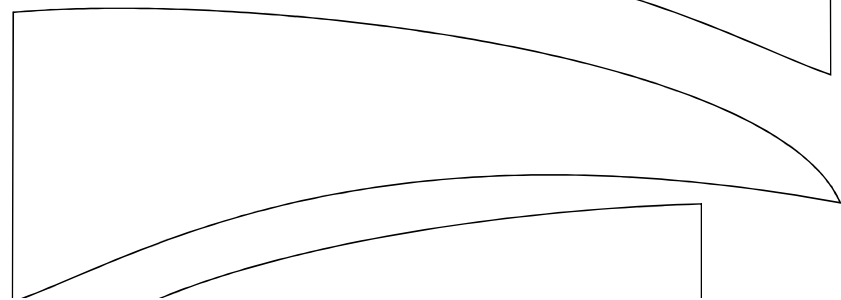
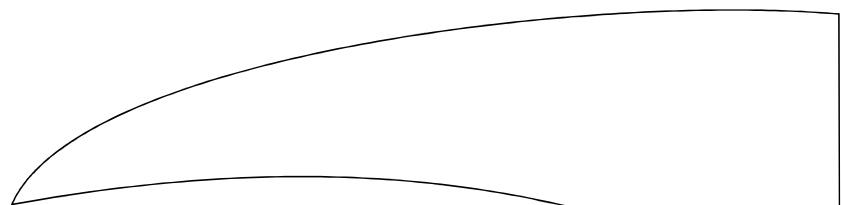
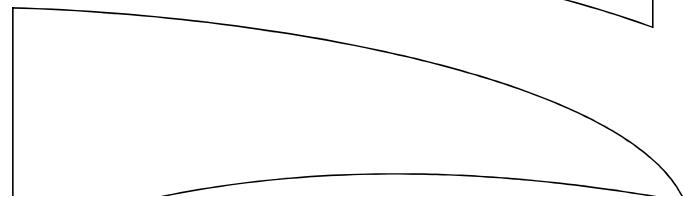
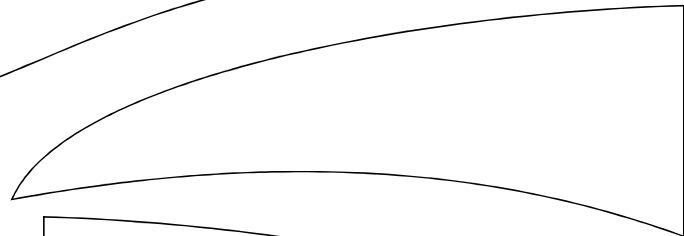
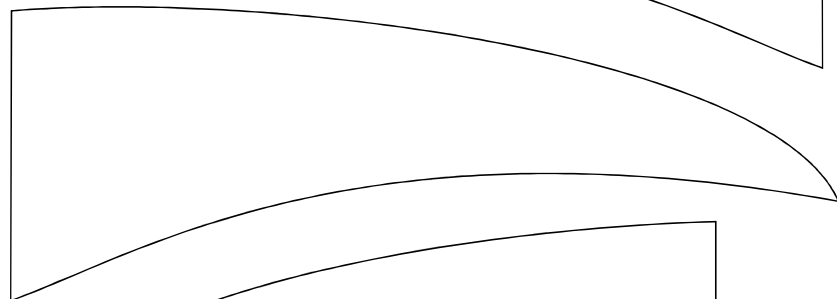
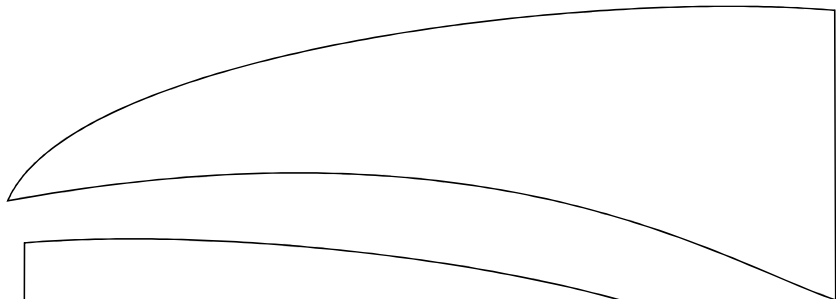
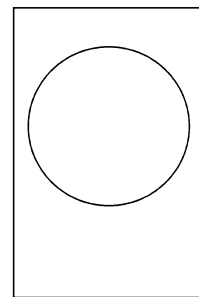
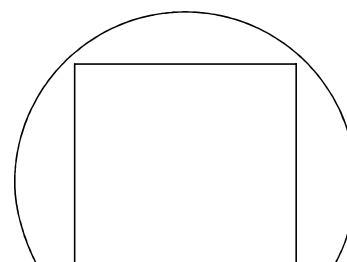
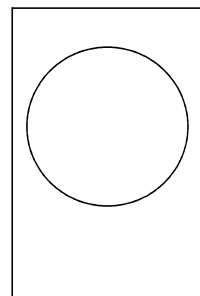
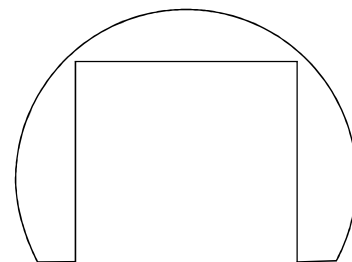
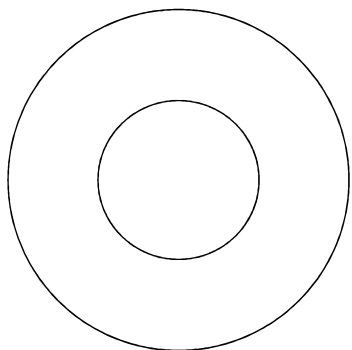
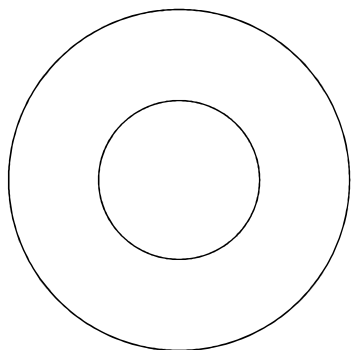

(2, 2)

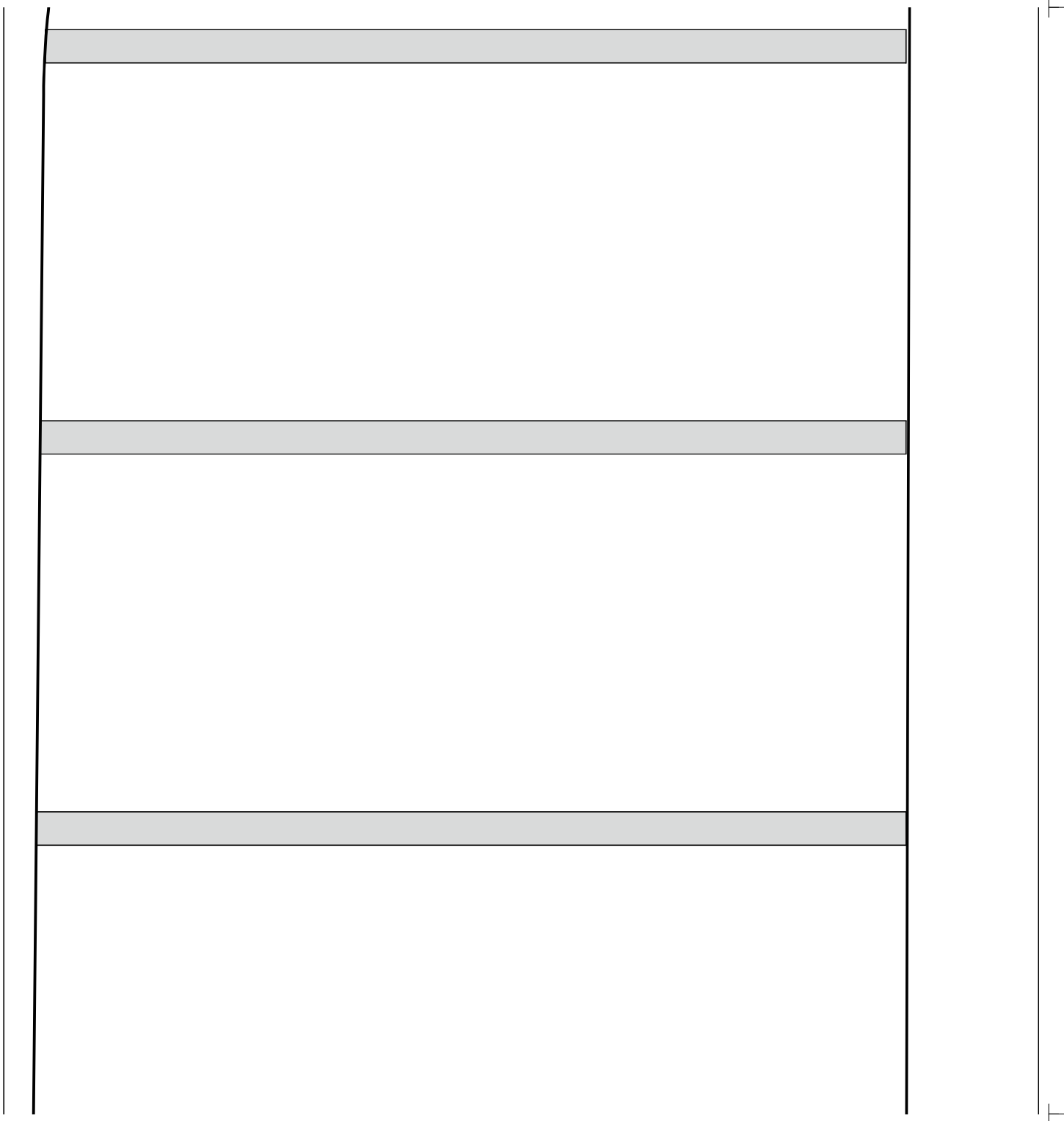
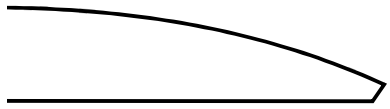

(1, 3)

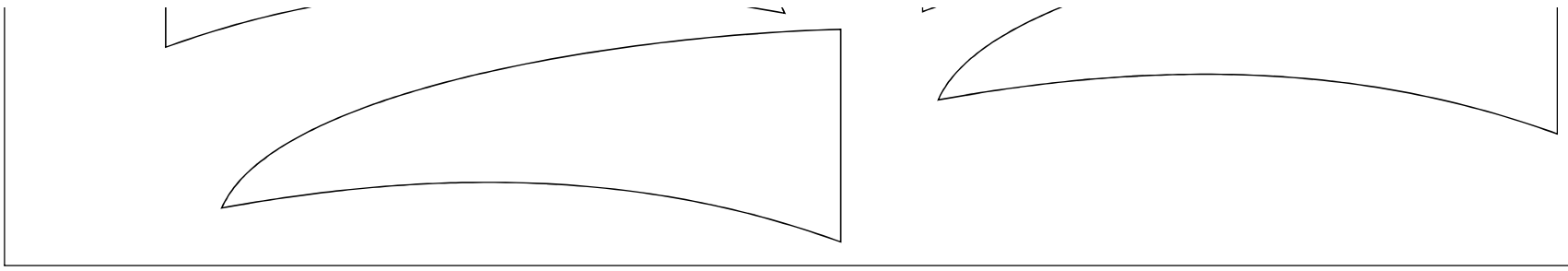

5

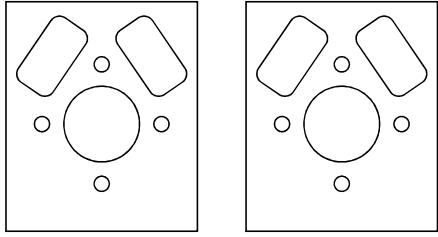

2mm Flugzeugsperrholz

T

(2, 3)

5-6mm Depron

